

6 SERIES AGROTRON



DEUTZ-FAHR
6 SERIES Power Shift Agrottron
6 SERIES TTV Agrottron



SOME OPTIONS AND/OR SPECIFICATIONS SHOWN MAY NOT BE AVAILABLE IN ALL MARKETS



THE NEW 6 SERIES.
THE BEST TECHNOLOGY
MIX IN ITS CLASS.



6 SERIES AGROTRON		6155	6155	6175	6215	6215
		PS / RCshift	TTV	TTV	PS / RCshift	TTV
Max. power (ECE R120)	HP	156	156	176	212	212
Max. power with boost (ECE R120)	HP	-	-	-	226	226

The agricultural industry is highly diverse. Each individual enterprise has its own totally individual success strategy. Some go for size, others for specialization. In milk production, in livestock, or in the cultivation of special types of crops. Others successfully adopt a mixed approach in accordance with soil and climate conditions as well as market opportunities. Whether it's a large, medium or small enterprise, a contractor or a local authority, however diverse the profile, they all have one thing in common – they need to be successful. Accordingly, tractor technology needs to 100% match their working profile.

plowing, planting, cultivating, transporting, harvesting crops, front loader work – each individual professional will decide how the tractor will be utilized, along with which specific features are required. DEUTZ-FAHR has developed the new 6 Series with this in mind. With 5 models ranging from 156 to 226 HP, two wheelbases, three transmission variants, two cabin types with different comfort levels, and various other feature options, you can put together the best technology mix in this tractor class, and create your own, totally individual tractor. With the 6 Series, DEUTZ-FAHR has redefined the configurability concept.

WITH EVERY OPERATION ON THE FARM, IN THE FIELD OR ON THE ROAD, 'HOW COMFORTABLE SHOULD A TRACTOR BE?' WITH THE NEW 6 SERIES, DEUTZ-FAHR HAS THE ANSWER: 'AS COMFORTABLE AS YOU WANT IT TO BE.'



CAB COMFORT
OPTIONS. THE CHOICE IS YOURS.



In general, the higher the driving and operating comfort, the more relaxed the work. And the more relaxed the work, the better the results. For this reason, all 6 Series models offer first class cabin comfort. Unique to the market: You can choose from a multitude of technology, equipment, specification and comfort variants. The choice is yours, based on the intended purpose of the tractor, on the driver's demands and, of course, the economic factors - whatever the requirements, the new 6 Series has all the bases covered. MaxiVision and MaxiVision 2 cabs offer

different operating comfort levels depending on the technological features included. From simple manual gear shift to the most advanced electronic joystick control unique to 6 Series. You can choose between three roof types - a simple green sliding roof, a glass roof with UV absorption or the FOPS safety version for piece of mind while using a front loader. Whatever you choose, the new 6 Series will meet your personal demands.



**MAXIVISION 2 CAB.
EVERYTHING FOR A RELAXED
WORKING ENVIRONMENT.**



The highlights:

- Broad configuration options
- Quieter, with reduced vibration and heat thanks to the separation between cab and hood
- All round visibility, thanks to the design and use of cab glass, optimized hood dimensions and compact EAT layout
- Up to 40,000 Lumen LED package

The unique features offered by MaxiVision and MaxiVision 2 can be seen inside and also from outside the cab. When it comes to ease of use and ergonomics, the new 6 Series caters for the operator by making best use of the current technology available. The InfoCentre^{Pro} on the dashboard features a 5" color display, providing the driver with a stream of data about the tractor's operating conditions. It offers maximum convenience in terms of settings and information. On TTV models there is an additional WorkMonitor fitted on the right pillar, performing real time working information. The interior provides a peaceful working environment, with all engine noise, vibrations and heat reduced to a minimum as there is no connection between the cab and engine. The new hood encapsulates the latest, highly contemporary look of the DEUTZ-FAHR tractor family, while its optimized design also ensures outstanding forward visibility. The best possible view of rear attachments is guaranteed by the rearward position of the cab. In order to allow precise, stress-free work in all lighting conditions, it can be fitted with an optional 40,000 lumen LED package with up to 16 working headlights.



State-of-the-art dashboard cluster with new InfoCentre^{Pro} : 5" high-res LCD color display for customizable top information concept.



Up to 16 (IV Generation, 2500 Lumen) LED working lights.



New hood. Maximum view of front implements.



Sunroof with 3 different configurations.

Other features that enhance comfort and functionality are the color coded controls, the large windows and a new closing system for the right hand door. The air conditioning system – with new automatic functions – optimizes the internal temperature, while the largest number of air outlet openings in this tractor class guarantee uniform air distribution like no other model. With the MaxiVision and MaxiVision 2 cabs, you can look forward to extremely comfortable and efficient work.



INTUITIVE OPERATION FROM
MANUAL TO FULLY AUTOMATIC.



The newly designed armrest makes the 6 Series even more relaxing and intuitive to operate. All routine functions can be automated. The new, highly ergonomic MaxCom joystick on the armrest controls everything from driving speed, direction of travel and cruise control selection to the ComfortTip system, rear and front lift controls. An intuitive system that requires no change of hand position and no more than a moment's thought to operate. The MaxiVision 2 cab is offered on TTV models with electro-hydraulic spool valves, and the MaxiVision cab for RCshift or Power-shift models, is fitted with mechanical spools and electro-



Hydraulic valves can be managed through proportional and programmable controls. The electronic joystick can be programmed to use the front-loader and other tractor functions with the thumbwheel.



Standard in all cab configurations, the PTO engagement comes with the easy but safe push-button controls.



Fine tuning front (TTV only) and rear lift control can be operated through dedicated controls.

hydraulic spool valves as an option. For all models, the front lift and front loader controls can be mechanical or electro-hydraulic depending on the configurations. Each model is equipped with the new InfoCentre^{Pro}: a new digital dashboard with 5" LCD display, integrated within the tiltable steering column in the central console. All of the controls are clearly marked with colors and are logically arranged according to their frequency of use. The driver has complete control over the new 6 Series at all times and can work for very long periods at maximum productivity.

HOW TO FULLFILL THE GROWING DEMANDS FOR SUSTAINABILITY AND ECO-FRIENDLINESS BUT STILL WORK WITH MAXIMUM EFFICIENCY AND POWER? SIMPLY GET INTO THE NEW 6 SERIES.



THE BEST MIX OF TECHNOLOGY FOR OPTIMUM EFFICIENCY.



The highlights:

- New efficient Deutz TCD 6.1 liter engine
- Stage 4 (Tier4 Final) with passive DPF without injector
- New optimized engine mapping for a faster reaction speed and wider constant torque
- Up to 5% average lower fuel and AdBlue consumption
- Electronic Visco fan for higher efficiency (TTV models)
- Exhaust engine brake - 40% more braking power

The new 6 Series is equipped with a completely redesigned engine in terms of environmental impact and cost-effectiveness. The new DEUTZ 6.1 Stage 4 (Tier4 Final) engine is more responsive, offers higher reserve torque with a higher starting torque and, at the same time, consumption of fuel and DEF has been reduced.

The new exhaust system features SCR after treatment and an additional, passive DPF (diesel particulate filter). DPF offers three advantages compared to the usual active filters: no fuel injection directly into the filter, less heat is generated around the unit and an efficient "heat-mode" strategy of the engine reduces the regeneration process. This saves fuel and money while conforming to all international emission standards. On TTV models, the efficiency of the engine is also supported by an Electronic Visco fan.

TTV models can be equipped with the new exhaust engine brake for 40% more braking power. This system provides increased braking efficiency and reduced stress to the service brakes, as well

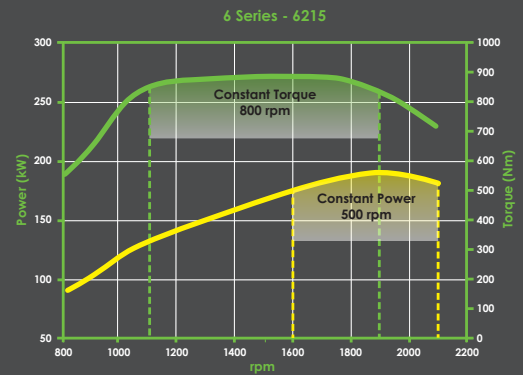

500 rpm of constant power with a peak of 226 HP: more than 200 HP available at 1600 rpm. A wide range of constant torque, from 1100 to 1900 rpm, with 94% of torque available. In simple terms, almost maximum torque for the entire working engine rpm range.

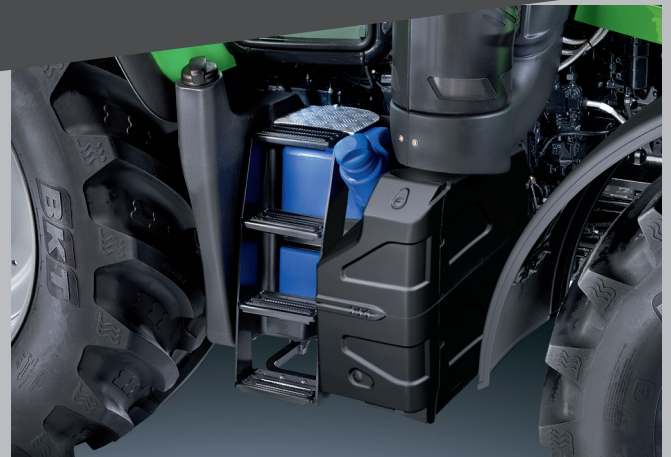

Less fuel and DEF consumption. 74 gallon diesel and 9.2 gallon DEF tank for long working days.



SCR after treatment system and passive DPF (diesel particulate filter) save fuel and costs.

as increasing safety and decreasing service costs. The operation is comfortable, easy-to-use and reliable via an additional foot pedal that is controlling a butterfly valve.

The DEUTZ 6.1 Stage 4 (Tier4 Final) engine utilizes modern technology and is engineered and manufactured in Germany - synonymous with the highest levels of reliability and efficiency, allowing you to achieve maximum output.



THE NEW COOLING SYSTEM.
COMPACT, EFFECTIVE AND EASY
TO MAINTAIN



The highlights:

- Exclusive radiator opening system for quick and easy cleaning
- Aluminum material – lighter construction
- Higher heat radiation

The newly designed cooling system – designed in collaboration with Italdesign Giugiaro – considerably improves engine efficiency through higher heat radiation capacity. All radiators and connection elements are made in aluminum for a greater thermal dissipation. The exclusive opening system allows the radiator to be fully opened, which enables faster and easier maintenance.

When closed, the cooling system is very compact and allows the engine hood to sit lower for a clear view of the front attachment points. Above the radiators a special cover integrates the air-prefilter



Efficient and compact cooling system for inter cooler, engine, transmission and fuel cooler, and air conditioning condenser.



Pre-cleaning system of the air intake filter: spiral tubes and an aspirator hose removes 95% of the dust before entering the primary filter.

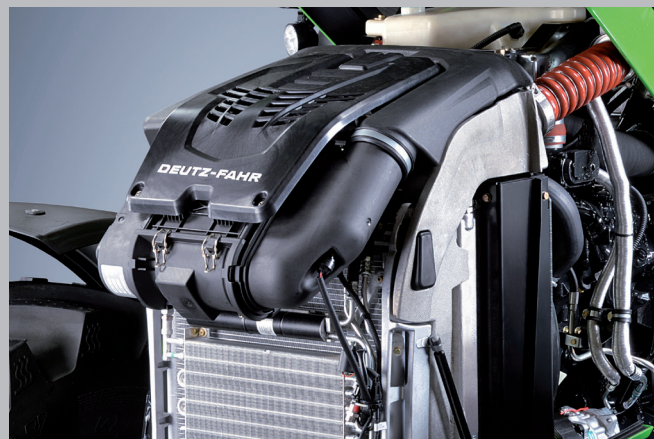

PowerCore technology air filter: 20% higher air flow capacity than comparable standard filters.

where the air enters a pre-cleaning area which consists of a series of spiral cyclone tubes. The tubes force the dust and debris to the outer part of the housing, which in turn extracts the heavier dust particles and removes them before they enter the main filtration system.

The air cleaner system used is the proven PowerCore air filtration system - state-of-the-art for maximum filtration, reliability and efficiency.

FOR THE MOST EFFICIENT WORK
YOU NEED TO FIND THE RIGHT SPEED
QUICKLY AND PRECISELY – EVEN WITH
HEAVY LOADS AND ON STEEP TERRAIN.
THE NEW 6 SERIES ENSURES THAT
EVERYTHING KEEPS GOING
AT THE BEST LEVEL FOR YOU.



POWERSHIFT OR TTV.
THE CHOICE OF TRANSMISSION
IS YOURS.



Powershift: The efficient all-round transmission with manual gear changing.



TTV transmission. Premium performance, optimum efficiency and maximum comfort at work.

What is the main area of focus for your tractor? Simple farmyard work? Grassland work? Haulage? Heavy tillage applications? Or a mixture of all these? Whatever the focus of your new 6 Series, it offers exactly the right transmission for any driver and any operation.

Simplest manual Powershift transmission: with 5 mechanical gear speeds plus 6 Powershift steps forward and 3 reverse, total number of speeds 30+15 (with creeper: 54+27). 25 mph or 31kph maximum speed (according to the market regulation), all at reduced engine speeds.

Fully automatic RCshift transmission: with 5 robotized speeds plus 6 Powershift steps forward and 3 reverse, total number of speeds 30+15 (with creeper: 54+27). High speed and high torque transmission feature.

TTV transmission: Maximum comfort in a highly adaptable transmission. This efficient and reliable system is capable of varying

speed continuously, optimizing engine power without unnecessary loading or fuel wastage, resulting in more productive work. These operating principles allow the TTV transmission to quickly provide the required driving speed, ensuring a smooth drive and advantages in terms of on-the-move comfort and safety, particularly when driving on the road.

All transmissions are easy to operate, simple to program and easy to monitor via the on board displays. They each offer excellent efficiency, precision and effectiveness. However, what is unique about the new 6 Series is that you can choose the level of transmission technology you want.



TTV TRANSMISSION.
WELCOME TO THE PREMIER
LEAGUE OF COMFORT.



The highlights:

- 3 driving modes
- Highly efficient and extremely comfortable
- Stepless speed control from 0 up to 31 mph
- Up to 4 Cruise speeds available (2 forward + 2 reverse)

Maximum productivity is the result of a precisely powered transmission and exact working speeds. The new 6 Series is fitted with state-of-the-art electronically controlled continuously variable TTV transmission. It is a solid concept that has been tried and tested over the years, now with new software for even better performance. Three driving modes are available to ensure a perfect fit for every working situation: manual, automatic and PTO. Overall, the speed range extends from 0.12mph to 31 mph, according to the markets regulation. The TTV transmission system is designed to be efficient at all speeds, providing a highly comfortable and extremely efficient system thanks to its four mechanical ranges which change automatically. Engine and transmission management is fully integrated, enhancing the functionality of the cruise settings. A trailer stretch mode increases safety in steep challenging conditions.

Every single detail of the TTV transmission system has been designed to maximize the productivity of the 6 Series.

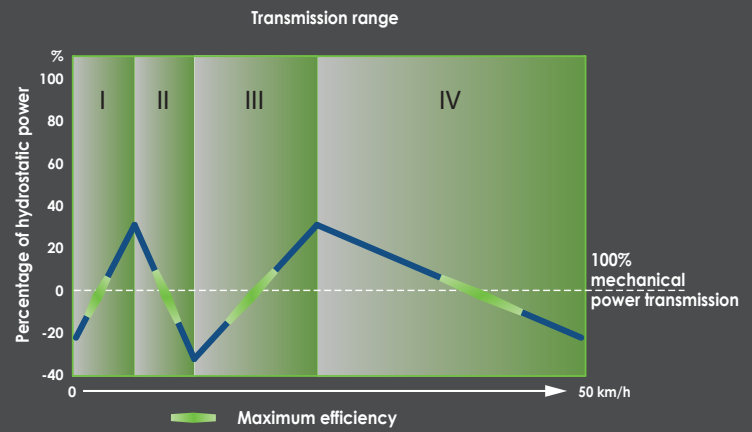

TTV technology now available up to 226 HP from the 6 Series (model 6215).



With a top speed of 31 mph (where permitted) the new 6 Series TTV is also a true transport professional. By simply pressing two buttons on the joystick, the driver can recall 4 different speed settings whether in the field or on the road and maintain a constant speed for optimum results.



**NEW FRONT AXLE
- NO COMPROMISE BETWEEN
SAFETY AND DRIVING COMFORT.**



The highlights:

- Unique front axle with electronically controlled suspension
- Maximum stability in all working conditions
- Booster brake system
- Standard EPB on TTV models

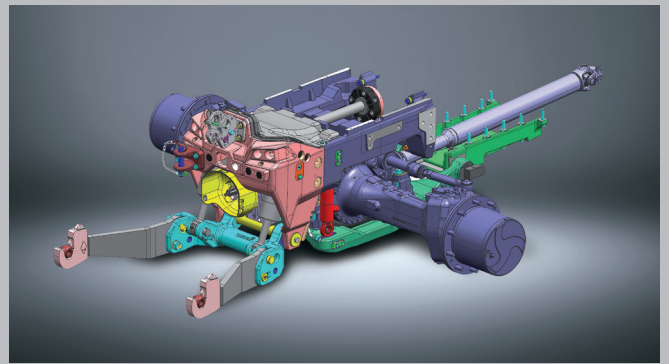

Electronic adaptive suspension incorporating an Anti-Dive and Anti-Rise system. The suspension can be used in the field and on the road. Fully lockable when needed.



TTV models - EPB replaces the handbrake lever and is operated via an electric push-button control on the armrest console.

The new front axle suspension and braking system of the 6 Series is unique in this performance class. The front axle is now fitted with double-acting hydraulic cylinders and a longer stroke, significantly increasing the damping effect, which is also electronically controlled. Depending on the brake intensity and driving speed, two suspension levels are activated – the Anti-Dive and Anti-Rise system, or the complete suspension system for the field and on road; the suspension system can also be locked. The 6 Series TTV is the only standard tractor that is fitted with high performance dry disc brakes on the front axle, with the additional Booster brake system ensuring

maximum braking performance with the lightest pedal pressure.

TTV models are equipped with the EPB (Electronic Parking Brake): the automatic parking brake system which acts on the rear brake discs. The EPB automatically disengages when the shuttle direction is activated and automatically engages when the driver leaves the seat.

OUT WORKING IN HAY WITH A
MOWER COMBINATION IN THE
MORNING - FRONT LOADER AND
TRANSPORT WORK IN THE AFTERNOON,
FOLLOWED BY A DAY OF HEAVY TILLAGE
WORK. THESE ARE THE STRENGTHS OF
THE 6 SERIES.

THE CONNECTION POINTS.
PREPARED FOR A WIDE RANGE
OF APPLICATIONS.



The highlights:

- Broad configuration
- Mechanical or electro-hydraulic control
- Hydraulic proportional valves (MaxiVision 2 cab)
- Position-controlled front linkage (TTV models)
- New front lift concept - integrated to the tractor

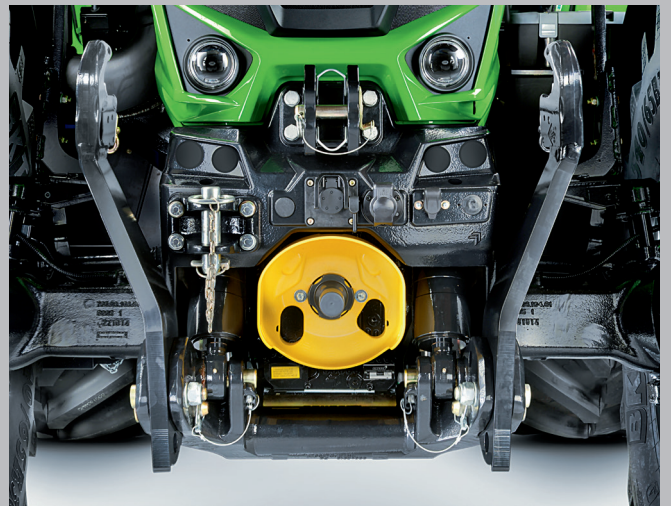

New front lift position control for more work capacity (only TTV models).



External hydraulic, rear lift and PTO remote controls from each side.

The attachment points of the new 6 Series are available with a wide range of feature options. For the hydraulics, you can choose between mechanical and electro-hydraulic controls, up to five hydraulic valves in the rear and two in the front, and a hydraulic pump output of up to 45 gpm, with a rear lifting capacity up to 22,025 lb. The models with the MaxiVision 2 cab offer proportionally controlled hyd valves, for a broader scope of operation and control. A separate oil tank ensures an ample supply for the TTV models. The main hydraulics are offered with a Load sensing system or an open center constant flow pump. The new front support with new integrated front lift is designed to match the front suspension, providing a compact layout for maximum steering capability, offering up to 11,000 lb lift with up to 2 dedicated

front valves. This new front linkage system is also equipped with a position control function, and can be fitted with an integrated ISOBUS terminal.

With four PTO speeds 540/540E/1000/1000E at the rear and 1000 at the front, all work can be carried out very efficiently at reduced engine speeds and fuel consumption. The new InfoCentre^{Pro} provides clear, easily understandable information about hydraulic and PTO functions. All hydraulic and PTO functions can be easily set and controlled from the right console or armrest in the cab.



EVERY TILLAGE APPLICATION IS DIFFERENT, EVERY SOIL TYPE IS CHALLENGING, BUT ALL HAVE THE HIGHEST DEMANDS FOR PRECISION FARMING TECHNOLOGY.

PRECISION FARMING SYSTEMS.
HIGHEST ACCURACY
ON DEMAND.



The highlights:

- 6 Series offers the whole range of DEUTZ-FAHR Precision Farming technology from the factory
- IMonitor2 with 12" display.
- Optional easy steer system
- Section Control, TIM ready

The new 6 Series can be factory fitted with the most advanced precision farming technology, with unique features of the central monitoring and control units coupled with the iMonitor2 that offers a screen size of 8" or a market leading 12" version. Everything runs on a single, clear user interface, from tractor functions to ISOBUS applications, automatic steering, control systems and data management. Two independent cameras can be fitted as an option. The new 6 Series can also be TIM ready (Tractor Implement Management), if desired, this means, the tractor and the implement are becoming an intelligent, closed combination - technology to boost your precision and comfort at work.

Another option is the VT4 system, which makes it possible to control implements using the tractor's own systems, avoiding too many control boxes in the cab. The section control and variable rate control systems for sprayers and seeders are included as standard, allowing the driver to activate or deactivate sections in order to avoid overlap and to conserve crop protection agents and seed. Thanks to an optional remote control system, product specialists can support the operator remotely via the IMonitor screen. There are also automatic control systems as well as solutions for wireless data transmission and data management.



TIM ready (Tractors Implement Management) functions can follow implement functionality.

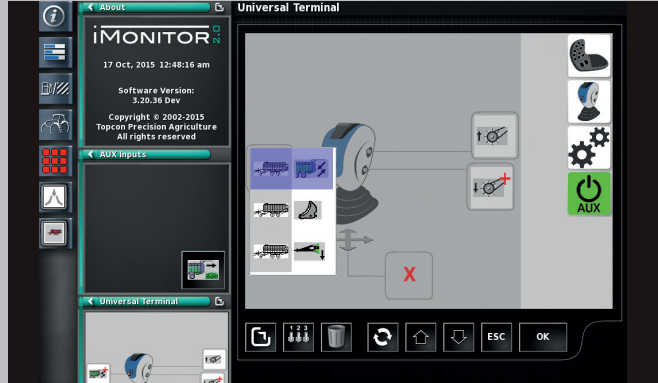

VT4 ready. Implement functions controlled by the tractor's own systems.



Section control/ variable rate control as standard.

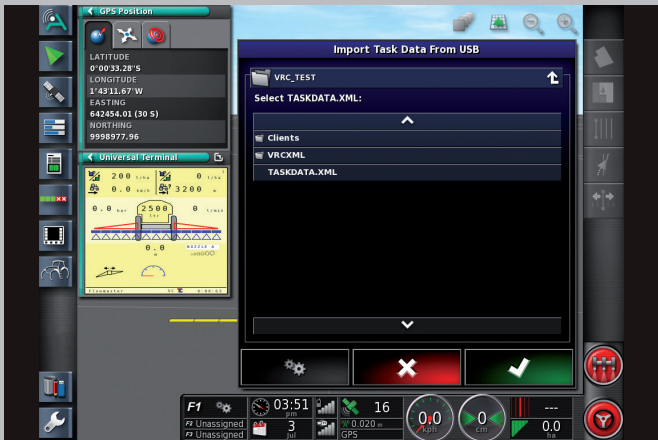

Thanks to the ISOXML standard, tasks can be planned, documented and evaluated with numerous agricultural field records.



FORM FOLLOWS FUNCTION.
BOTH FOLLOW THE NEEDS
OF FARMERS.



Front halogen lights fitted as a standard.



No connection between cab and engine hood - improved driver comfort.



Premium materials and attention to detail.

When it comes to the design of tractors, many people tend to view design purely in terms of the appearance of the tractor. Of course, appearance is important, but good design is more than that, it includes a variety of additional features. The person striving to make their work easier, is the primary consideration in all design plans. Countless series of tests have shown how viewing spaces, light concepts, ranges of motion, operating sequences and the integration of technical components should be designed and organized to make the driver's work as easy as possible and the tractor as efficient as possible as an overall system. The goal is to optimize all functions and ensure optimal interaction between the driver and the tractor. The very best tractor design has a name: Italdesign Giugiaro, one of the most

influential companies in vehicle design in the 20th and 21st centuries. With over 200 design concepts for international automotive and commercial vehicle brands, including many classic models, this famous company has made history. The new 6 Series makes the combined experience from over 100 years of DEUTZ-FAHR tractor construction and leading Giugiaro vehicle design available to agricultural entrepreneurs.

Technical data		6 SERIES Agrottron		
		6155	6175	6215
ENGINE				
Manufacturer		DEUTZ	DEUTZ	DEUTZ
Model		TCD 6.1 L06	TCD 6.1 L06	TCD 6.1 L06
Emissions		Stage 4 (Tier4 Final)	Stage 4 (Tier4 Final)	Stage 4 (Tier4 Final)
Cylinder / Displacement	No.	6	6	6
Turbo intercooler		●	●	●
Viscostatic fan		●	●	●
Deutz Common Rail (DCR)	PSI	23,200	23,200	23,200
Power at rated engine speed (ECE R 120)	hp	149	169	201
Max. power (ECE R 120)	hp	156	176	212
Power at rated engine speed with boost (ECE R 120)	hp	-	-	214
Max. power with boost (ECE R 120)	hp	-	-	226
Homologated Engine power in accordance with delegated regulation (EU) 2015/96	hp	149	169	214
Engine speed at maximum power	rpm	1900	1900	1900
Max. engine speed (rated)	rpm	2100	2100	2100
Maximum torque	lb-ft	489	545	655
Engine speed at maximum torque	rpm	1500	1500	1500
Torque rise	%	33	31	24
Electronic engine governor		●	●	●
Air filter with dust ejector		●	●	●
Exhaust After Treatment (EGR+DPF+SCR)		●	●	●
Fuel tank capacity	gal	74	74	115
AdBlue tank capacity	gal	9.2	9.2	13.2
TRANSMISSION				
Manufacturer		ZF	ZF	ZF
Model (Manual)		TPT16 / TPT16 RCshift	TPT16 / TPT16 RCshift	TPT20 / TPT20 RCshift
Number of speeds	No.	30+15	30+15	30+15
Powershift number of speeds (forward/reverse)	No.	6/3	6/3	6/3
Minimum speed with creeper gear	mph/kph	0.23/0.37	0.23/0.37	0.24/0.39
Max speed 50 Km/h (Manual/RCshift)	Km/h@rpm	-	-	50@1863 / 50@1447
Max speed 40 Km/h (Manual/RCshift)	Km/h@rpm	40@1575 / -	40@1575 / -	40@1490 / 40@1158
Driving Strategies (Manual/Semi-Auto/Full Auto) (RCshift only)		●	●	●
Automatic Powershift (RCshift only)		●	●	●
SpeedMatching		●	●	●
SenseShift		●	●	●
PowerShuttle with 5 adjustment levels		●	●	●
ComfortClutch		●	●	●
Multiplate wet clutch electrohydraulically operated		●	●	●
PTO				
PTO 540/540E/1000/1000E		●	●	●
AUTO PTO		●	●	●
Front PTO 1000		○	○	○
AXLES AND BRAKES				
Front axle manufacturer		Carraro	Carraro	Dana
Front axle model		20.29	20.29	M60L
Suspended front axle		○	○	○
Front axle with brakes		○	○	○
Agrosky autosteering predisposition with EasySteer function		○	○	○
Front and rear (50 or 100 mm) spacers		○	●	○
Front wheel drive electrohydraulically engaged		●	●	●
Electrohydraulically operated front and rear differential lock		●	●	●
Four-wheel braking system with automatic 4WD engagement		●	●	●
Powerbrake		●	●	●
Mechanical parking brake		●	○	●
Hydraulic trailer braking valve		○	○	○
Trailer air braking valve		○	○	○
Hydrostatic steering with independent pump		●	●	●
Steering pump capacity	gpm	13.2	13.2	13.2
Steering angle	degree	52	52	52

Technical data		6 SERIES Agrotion		
		6155	6175	6215
HYDRAULIC SYSTEM AND LIFT				
Variable displacement pump (load sensing) (standard)	gpm	31	32	31
Variable displacement pump (load sensing) (optional)	gpm	42	42	42
Auxiliary rear mechanical distributors (standard)	No.	2	4	2
Auxiliary rear mechanical distributors (optional)	No.	4	4	4
Auxiliary rear electrohydraulic distributors (RCshift only)	No.	4/5	5	4/5
Auxiliary front hydraulic distributors (ComfortPack)	No.	1/2	1/2	1/2
Power beyond		○	○	○
Electronically controlled rear lift		●	●	●
Radar		○	○	○
Rear lift capacity	lb	20,250	20,250	22,025
Right hand tie-rod and third mechanical point		●	●	●
Right hand tie-rod and third hydraulic point		○	●	○
Auto-hitch coupling bars		●	●	●
Controls on mudguard		●	●	●
Mechanical front lift with retractable coupling bars		○	○	○
Front lift capacity	lb	9,050	9,050	11,000
Quick couplers		●	●	●
ELECTRICAL SYSTEM				
External power outlet socket		●	●	●
Power outlet socket for sup. amperage		●	●	●
Implements interface ISO 11786		○	○	○
Implements interface ISO 11783		○	○	○
CAB				
MaxiVision or MaxiVision 2		●	●	●
MaxCom joystick (RCshift only)		●	●	●
iMonitor2 (12")		○	○	○
InfoCentre ^{pro} (5")		●	●	●
Agrosky system		○	○	○
ComforTip (Headland Management)		-	-	-
ComforTip professional (only with iMonitor2)		○	●	○
Max-Comfort Professional XL seat		●	●	●
Max-Comfort Dynamic XL seat		○	●	○
Padded instructor's seat		●	●	●
Mechanical cab suspension		●	●	○
Pneumatic cab suspension		○	○	○
Air conditioning		●	●	●
Automatic A/C system		○	○	○
Anti-UV high visibility roof with		○	○	○
Wiring for audio system with speakers		●	●	●
Telescopic external mirrors		●	●	●
Telescopic external electric and heated mirrors		○	○	○
Light control panel		●	●	●
Halogen work lights		●	●	●
4 Generation LED work lights		○	○	○
Integrated driving LED lights		○	○	○
Coming home function		●	●	●
DIMENSIONS AND WEIGHTS				
Wheelbase	in	109	109	112
Length (min-max)*	in	163-225	170-225	173-228
Height (min-max)**	in	115-119	119-121	122-124
Width (min-max)**	in	95-100	97-100	98-107
Ground clearance (min-max)**	in	14-18	18-20	21-27
Total unladen weight	lb	14,875	16,755	18,364
Maximum permissible total weight	lb	25,350	27,550	29,750

●: standard ○: optional -: not available

*Min length: from front hood to the rear lift arm in upper position / Max length: from front ballast with front-lift to the rear lift arm in lower position

**Min-Max: according to tires and equipment

Technical data		6 SERIES TTV Agrottron		
		6155 TTV	6175 TTV	6215 TTV
ENGINE				
Manufacturer		DEUTZ	DEUTZ	DEUTZ
Model		TCD 6.1 L06	TCD 6.1 L06	TCD 6.1 L06
Emissions		Stage 4 (Tier4 Final)	Stage 4 (Tier4 Final)	Stage 4 (Tier4 Final)
Cylinder / Displacement	No.	6	6	6
Turbo intercooler		●	●	●
Electronic Viscostatic fan		●	●	●
Deutz Common Rail (DCR)	PSI	23,200	23,200	23,200
Power at rated engine speed (ECE R 120)	hp	149	169	201
Max. power (ECE R 120)	hp	156	176	212
Power at rated engine speed with boost (ECE R 120)	hp	-	-	214
Max. power with boost (ECE R 120)	hp	-	-	226
Homologated engine power in accordance with delegated regulation (EU) 2015/96	hp	149	169	214
Engine speed at maximum power	rpm	1900	1900	1900
Max. engine speed (rated)	rpm	2100	2100	2100
Maximum torque	lb-ft	489	545	655
Engine speed at maximum torque	rpm	1500	1500	1500
Torque rise	%	33	31	24
Electronic engine governor		●	●	●
Exhaust engine brake		○	○	○
Air filter with dust ejector		●	●	●
Exhaust After Treatment (EGR+DPF+SCR)		●	●	●
Fuel tank capacity	gal	74	74	115
DEF tank capacity	gal	9.2	9.2	13.2
TTV TRANSMISSION				
Manufacturer		ZF	ZF	ZF
Model		Eccom 1.5/1.5 HD	Eccom 1.5/1.5 HD	S-Matic 180+
Number of internal ranges	No.	4	4	4
Max speed 50 Km/h	Km/h@rpm	-	50@1834/50@2100	50@2100
Max speed 40 Km/h	Km/h@rpm	40@1431/40@1641	40@1431/40@1641	40@1647
PowerZero		●	●	●
Cruise speed	No.	2 forward + 2 reverse	2 forward + 2 reverse	2 forward + 2 reverse
Driving Strategies (Auto/Manual/PTO)		●	●	●
Eco/Power control		●	●	●
Hydraulic reverse PowerShuttle		●	●	●
PowerShuttle with 5 adjustment levels		●	●	●
PTO				
PTO 540/540E/1000/1000E		●	●	●
AUTO PTO		●	●	●
Front PTO 1000		○	○	○
AXLES AND BRAKES				
Front axle manufacturer		Carraro	Carraro	Dana
Front axle model		20.29	20.29	M60L
Adjustable rear axle		○	○	○
Front and rear (50 or 100 mm) spacers		○	○	○
Suspended front axle		○	○	○
Front axle with brakes		○	○	○
Agrosky autosteering predisposition with EasySteer function		○	○	○
Front wheel drive electrohydraulically engaged		●	●	●
Electrohydraulically operated front and rear differential lock		●	●	●
Four-wheel braking system with automatic 4WD engagement		●	●	●
Powerbrake		●	●	●
EPB (Electronic Parking Brake)		●	●	●
Hydraulic trailer braking valve		○	○	○
Trailer stretch function		●	●	●
Trailer air braking valve		○	○	○
Trailer air + hydraulic braking valve		○	○	○
Hydrostatic steering with independent pump		●	●	●
Steering pump capacity	gpm	13.2	13.2	13.2
Steering angle	degree	52	52	52

Technical data and pictures are manufacturer's estimates. DEUTZ-FAHR reserves the right to update the specifications of its machines at any time without notice. Max speed of 50 kph where permitted. Max 40/50 kph at low rpm according to tires size.

Technical data	6 SERIES TTV Agrotрон			
		6155 TTV	6175 TTV	6215 TTV
HYDRAULIC SYSTEM AND LIFT				
Manufacturer		Bosch	Bosch	Bosch
Variable displacement pump (standard)	gpm	32	32	32
Variable displacement pump (optional)	gpm	42	42	42
Closed centre hydraulic system (load sensing)		●	●	●
Auxiliary rear electrohydraulic distributors (standard)	No.	4	4	4
Auxiliary rear electrohydraulic distributors (optional)	No.	5	5	5
Auxiliary front electrohydraulic distributors (optional)	No.	1/2	1/2	1/2
Electrohydraulic control with flow regulator and timer		●	●	●
Power beyond		○	○	○
Maximum deliverable quantity of oil	gal	10.5	10.5	10.5
Separate oil tank	gal	13.2	13.2	13.2
Electronically controlled rear lift		●	●	●
Radar		○	○	○
Rear lift capacity	lb	20,250	20,250	22,025
Right hand tie-rod and third mechanical point		●	●	●
Auto-hitch coupling bars		●	●	●
Controls on mudguard		●	●	●
Electronically controlled front lift		○	○	○
Front lift capacity	lb	9,050	9,050	11,000
Quick couplers		●	●	●
ELECTRICAL SYSTEM				
External power outlet socket		●	●	●
Power outlet socket for sup. amperage		●	●	●
Implements interface ISO 11786		○	○	○
Implements interface ISO 11783		○	○	○
CAB				
MaxiVision 2		●	●	●
MaxCom multifunction armrest		●	●	●
iMonitor2 (12")		○	○	○
WorkDisplay		●	●	●
InfoCentre ^{pro} (5")		●	●	●
Agrosky system		○	○	○
ComforTip (Headland Management)		●	●	●
ComforTip professional (only with iMonitor2)		○	○	○
Max-Comfort Dynamic XL seat		●	●	●
Max-Comfort Dynamic XXL seat		○	○	○
Max-Comfort Evolution Active DDS seat		○	○	○
Padded instructor's seat		●	●	●
Mechanical cab suspension		●	●	●
Pneumatic cab suspension		○	○	○
Air conditioning		●	●	●
Automatic A/C system		○	○	○
Anti-UV high visibility roof with		○	○	○
Wiring for audio system with speakers		●	●	●
Telescopic external mirrors		●	●	●
Telescopic external electric and heated mirrors		○	○	○
Light control panel		●	●	●
Halogen work lights		●	●	●
4 Generation LED work lights		○	○	○
Integrated driving LED lights		○	○	○
Ambience light		●	●	●
Coming home function		●	●	●
DIMENSIONS AND WEIGHTS				
Wheelbase	in	109	109	112
Length (min-max)*	in	163-225	170-225	173-228
Height (min-max)**	in	115-119	119-121	122-124
Width (min-max)**	in	95-100	97-100	98-107
Ground clearance (min-max)**	in	14-18	18-20	21-27
Total unladen weight	lb	17,262	18,275	18,900
Maximum permissible total weight	lb	25,350	27,550	29,750

●: standard ○: optional -: not available

*Min length: from front hood to the rear lift arm in upper position / Max length: from front ballast with front-lift to the rear lift arm in lower position

**Min-Max: according to tires and equipment

PREMIUM GERMAN LOADERS



For over 25 years, Deutz-Fahr has been using premium German Stoll loaders and implements. They are designed to lift more and load more with maximum efficiency.



↑ Stoll loaders are built to match your Deutz-Fahr.



↑ Excellent visibility even at maximum height.

PROFILINE FZ

SELF LOADING LOADERS FROM STOLL

			FZ 50/50.1	FZ 60/60.1
Series			6 Series Agrotron	6 Series Agrotron
DIMENSIONAL SPECIFICATIONS				
A	Maximum Lift Height at Pivot Point	in	168	176
B	Maximum Lift Height under Level Bucket	in	159	167
C	Overloading Height	in	126	134
D	Reach at Maximum Lift Height	in	31	31
E	Maximum Dump Angle	deg	59	59
F	Maximum Rollback Angle	deg	46	46
G	Digging Depth	in	8.3	8.3

LIFT CAPACITY at 2828psi (195 bar)				
AT PIVOT PIN, MAX LIFT HEIGHT		lbf	5308	5853
AT PIVOT PIN, GROUND LEVEL		lbf	6516	6824

AT 31.5" FORWARD OF PIVOT POINT, MAX LIFT HEIGHT		lbf	5308	5853
AT 31.5" FORWARD OF PIVOT POINT, GROUND LEVEL		lbf	6516	6824

BUCKET ROLLBACK FORCE at 31.5" / 800mm forward of pivot point				
AT GROUND LEVEL		lbf	8877	8824

WEIGHT (loader boom only)		lbs	1499	1742
---------------------------	--	-----	------	------

- ✓ Front loader lifting arms made from fine grain steel
- ✓ Z-kinematics, internal control rod
- ✓ Concealed hydraulic pipes with service access
- ✓ Dual-action hydraulic cylinders
- ✓ DX bushings for all loader pivot points
- ✓ COMFORT-DRIVE
- ✓ Standard 3rd service diverter
- ✓ Optional: Live 3rd function

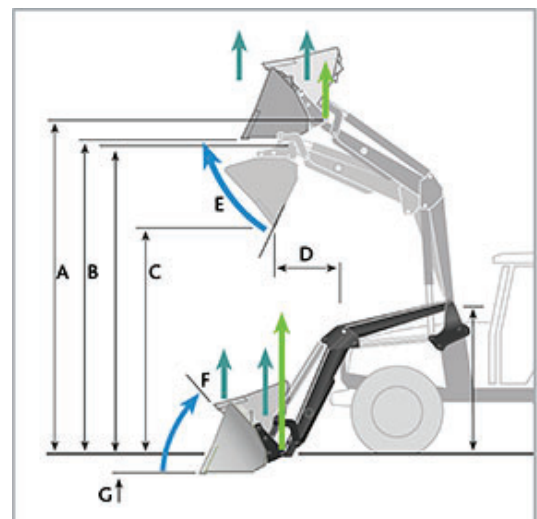

Dealer

Deutz-Fahr America
535 Hurricane Shoals Court
Suite 100
Dacula, GA 30019
www.deutz-fahramerica.com



Precision Production
Premium Tractors



Deutz-Fahr and its logos are trademarks of Same Deutz-Fahr Italia S.P.A. in the U.S. and other countries used under license by PFG America, LLC. PFG America and logo are trademarks licensed to PFG America, LLC, which is the exclusive distributor of the Deutz-Fahr brand in the USA. Other logos are the trademarks of their respective owners. The standard and optional equipment and the availability of individual models might vary from one country to the next. PFG America reserves the right to undertake modifications without prior notice to the design and technical equipment at all times without any obligation whatsoever to make such modifications to units already sold. This brochure is for descriptive purposes only and while reasonable efforts were made to ensure that the specifications, descriptions, and illustrations in this brochure are correct at the time of printing, these are also subject to change without prior notice. Illustrations might show optional equipment, and might not show all standard equipment. PFG America disclaims all representations and warranties, express or implied, or any liability from the use or reliance upon this brochure. Power and other specifications are based on various standards or recommended practices not addressed herein. ©2018 PFG America, LLC. All Rights Reserved.